

**Operating and installation instructions
Heating Controller Lago 0321**



Translation from the German
© 2008–2011 Elster GmbH

Safety

Please read and keep in a safe place



Please read through these instructions carefully before installing or operating. Following the installation, pass the instructions on to the operator.

These instructions can also be found at www.docuthek.com.

Explanation of symbols

•, **1**, **2**, **3**... = Action

▷ = Instruction

Liability

We will not be held liable for damages resulting from non-observance of the instructions and non-compliant use.

Safety instructions

Information that is relevant for safety is indicated in the instructions as follows:

⚠ DANGER

Indicates potentially fatal situations.

⚠ WARNING

Indicates possible danger to life and limb.

! CAUTION

Indicates possible material damage.

All work and settings in the chapters “Expert” may only be carried out by a qualified technician. Electrical interventions may only be carried out by a qualified electrician. The heating system must be disconnected from the power supply before any electrical work is carried out on the unit.

Conversion

All technical changes are prohibited.

Transport

On receipt of the product, check that the delivery is complete. Report any transport damage immediately.

Storage

Store the product in a dry place. Ambient temperature: see Technical data.







Table of contents

Heating Controller Lago 0321	1
Safety	1
Table of contents	2
Verify type of application	6
Type designation codes	6
Part designations	6
Selector switch	6
Display	7
User – Settings	8
Set time and day of the week	8
Set the desired temperature	8
Desired room temperature Day	8
Setback temperature (desired room temperature Night)	8
Desired hot water temperature	8
Display actual temperatures	8
Set operating mode	8
⏻ Standby/OFF	9
🕒1 Automatic mode 1	9
🕒2 Automatic mode 2	9
☀ Day mode	9
🌙 Night mode (reduced night mode)	10
☀ Summer mode	10
🔧 Service	10
🏠 HO Holiday	10
Set heating program 1	11
Set heating program 2	11
Load factory settings (Reset)	12

User – Set parameters	12
List of parameters P01 to P19.	13
Explanation of the parameters	14
P01 – P07 Heating program 2 (Monday to Sunday)	14
P08 Operating mode direct heating circuit (HC1)/ P13 Operating mode mixer circuit (HC2)	14
P09 Heat slope direct heating circuit/ P14 Heat slope mixer circuit	14
P10 Room sensor influence direct heating circuit/ P15 Room sensor influence mixer circuit	15
P11 Room sensor correction direct heating circuit/ P16 Room sensor correction mixer circuit	15
P18 Hot water according to program	15
P19 Indication of heating program at the lower margin of the display ..	16
User – Questions	16
How do I switch to summer/winter time?	16
How do I set the heating controller so that it gets warm sooner in the morning?	16
My heater does not get warm enough. What can I do?	16
How do I set the heating system for holidays?	17
How can I switch the heating system off during the summer? ..	17
Is it possible to let the heating system run longer in the evening for special occasions such as a party?	17
How do I set the heating controller to save energy?	17
Which room is allocated to which heating circuit?	17
My heating system is not running.	17

Expert - Installation	18	P32 Warm-Up Temp	34
Expert - Electrical connections	18	P33 Minimum limit heat source	34
Define application	18	P34 Dynamic switching hysteresis	35
Connection diagram controller without socket	21	P35 Hysteresis time	35
Connection diagram controller with socket	22	P36 Burner starts	35
Options	23	P37 Burner operating time	35
Maximum limiter	23	P38 Address heating module (only for cascade operation)	35
Examples of installations	24	P50 DHW Relief (charging pump lock)	35
Heating system controller for heat source, mixed heating circuit and hot water preparation	24	P51 Parallel pump operation	35
Heating system controller for mixed heating circuit and hot water preparation from a buffer storage tank	25	P52 Antilegion function	36
Heating system controller for direct heating circuit, mixed heating circuit and hot water preparation	26	P53 Temperature increase during hot water preparation	36
Controller for a mixed heating circuit as expansion for a heating system controller	27	P60 Maximum flow temperature direct heating circuit	36
Controller for a heat source in a cascade: Heating module	28	P61 Minimum flow temperature direct heating circuit	36
Internal hot water preparation of the first heat source in the cascade (hydraulic separation)	30	P69 Additional mixer functions (P77 – 79)	36
Expert – Set DIP switches	31	P70 Maximum flow temperature mixer circuit	36
Direct heating circuit or multifunction relay	31	P71 Minimum flow temperature mixer circuit	36
Assigning a remote control FBR2 to the direct heating circuit or mixer circuit	31	P72 Mixer Dynamic OPEN (when opening)/	
Set sensor resistance	31	P73 Mixer Dynamic CLOSED (when closing)	36
Expert – Set parameters	32	74 T-Flow Cooling (flow temperature Cooling)	37
List of parameters P20 to P99	33	P75 T-Room Cooling (desired room temperature)	37
Explanation of the parameters	34	P76 Min TO Cooling (Minimum outside temperature for cooling)	37
P20 Code no. input	34	P77 Mixer scan time	38
P21 code no. change	34	P78 Mixer operating time limit	38
P22 Outside temperature frost protection	34	P79 Mixer start seconds	39
P23 CAN bus ID mixer circuit (heating circuit address)	34	P80 MF Relay function	39
P30 Maximum heat source temperature	34	P81 Switching temperature of the multifunction relay	40
P31 Heat source minimum temperature	34	P82 Multifunction relay hysteresis	40
		P97 PC enable (0000 = disabled)	40
		P98 Relay Test	40
		P99 Software version and index (63.XX)	40
		Expert – Checklist for commissioning	41
		Service	42
		STL Test	42

Table of contents

Accessories	43
Operating module Merlin BM, BM 8, or remote control Lago	
FB	43
Merlin BM	43
BM 8	43
Lago FB	43
PC Adapter	43
CoCo PC active	44
CoCo PC mobile	44
Remote control and room sensor FBR2 	44
Room sensor RFB 	44
Sensor	45
Outside sensor AF/AFS 	45
Boiler sensor KF/KFS 	45
Storage sensor SPF/SPFS 	45
Flow sensor VF/VFAS 	45
Sensor values	46

Help with faults	47
Technical data	49
Glossary	50
Flow and return flow temperature	50
Desired and actual temperature	50
Setback temperature	50
Heat source	50
Circulation pump	50
Direct heating circuit	50
Mixed heating circuit / Mixer circuit	50
Heating time	50
Header pump	51
Feed pump	51
Legionella	51

Declaration of conformity 51

Heating circuit allocation 52

For the installation expert 52

Contact 52

Verify type of application

Verify type of application

Heating controller to be used as a

- heating system controller,
 - mixer extension or
 - as a controller for a heat source in a cascade,
- for further explanation see page 18 (Expert - Electrical connections).
The heating controller regulates two independent heating circuits: one indirect heating circuit and one mixer circuit.

The function is only guaranteed within the specified limits, see page 49 (Technical data).

Any other use will be deemed improper use.

Type designation codes

Code	Description
Lago	Heating controller
0	On//Off boiler control
3	Mixer circuit and hot water preparation
2	Temperature-controlled multifunction relay
1	CAN bus communication

Part designations

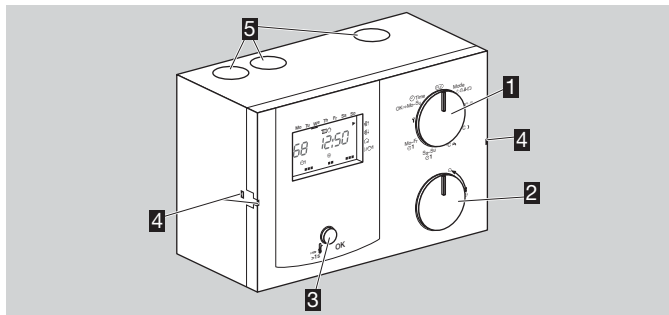

- 1** Selector switch
- 2** Rotary knob for changing the set values and displaying the temperatures
- 3** OK button for displaying the desired temperature of the heat source, for confirming settings, and the for testing the Safety Temperature Limiter
- 4** Assembly holder of the controller
- 5** Cable feed-throughs

Selector switch

(Run)	Standard
Mode	Operating mode selection
°C *	Desired room temperature Day (for both heating circuits)
°C)	Setback temperature (for both heating circuits)
°C H	Desired hot water temperature
Sa–Su	Heating program 1 from Saturday to Sunday
Mo–Fr	Heating program 1 from Monday to Friday
Y	Parameter setting for User and Expert
⊙ Time	Setting the time and the day of the week

Display

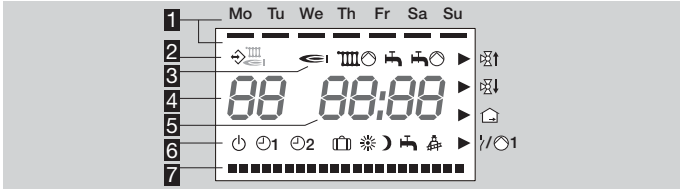



- 1 Days Monday – Sunday underlined
- 2 Communication to devices on the CAN bus (such as Lago FB, BM8, Merlin BM)
- 3 Status indications:
 - ➡ Burner,
 - ⊞ ○ Mixer circuit pump,
 - ⚡ ○ Hot water enabled,
 - ⚡ ○ Storage charging pump,
 - ⊞↑ Mixer open,
 - ⊞↓ Mixer closed,
 - 🏠 Room temperature,
 - ⚡/○1 Multifunction relay / Pump direct heating circuit
- 4 Heat source temperature (When used as a mixer expansion, "--" is displayed.)
- 5 Time

- 6 Operating modes:
 - ⏻ Operational readiness/OFF (Heating and hot water preparation OFF, frost protection operation only)
 - ⊞1 Automatic mode 1 (Heating according to heating program 1, hot water according to parameter 18)
 - ⊞2 Automatic mode 2 (Heating according to heating program 2, hot water according to parameter 18)
 - ⚡ Day mode (24 hour heating with desired room temperature Day, hot water according to parameter 18)
 - 🌙 Night mode (24 hour heating with setback temperature, hot water according to parameter 18)
 - ⚡ Summer mode (Heating OFF, hot water according to parameter 18)
 - ⚡ Service (Heat source controls to maximum heat source temperature.)
 - 🏠 Holiday mode (During holidays the rooms are heated to 15 °C, after the holidays the rooms are automatically heated according to heating program again.)
- 7 Display of the heating times

User – Settings

Set time and day of the week

- 1 Turn selector switch to  Time.
- 2 Press the OK button.
 - ▷ Display flashes.
- 3 Set time with rotary knob.
- 4 Press the OK button.
- 5 Set day of the week with rotary knob.
- 6 Press the OK button.
 - ▷ The new time and the day of the week is displayed.
- 7 Turn selector switch back to  .
 - ▷ To cancel the settings without saving, turn the selector switch back to  at any time.

Set the desired temperature

Desired room temperature Day

- ▷ Active during heating times
- 1 Turn selector switch to °C .

Setback temperature (desired room temperature Night)

- ▷ Active between heating times
- 1 Turn selector switch to °C .

Desired hot water temperature

- 1 Turn selector switch to °C .







All three temperatures

- 2 Press the OK button.
 - ▷ Display flashes.
- 3 Set day of the desired temperature with rotary knob.

- 4 Press the OK button.
 - ▷ The new desired temperature is displayed.
- 5 Turn selector switch back to  .

Display actual temperatures

- 1 Turn selector switch to .
- 2 Use the rotary knob to set one of the following temperature indications:

 + 	Room temperature for up to 8 heating circuits
	Outside temperature
 *)	Heat source and concurrently flow temperature of the direct heating circuits (1st HC)
 *)	Flow temperature of the mixer circuit (2nd HC)
 *)	Hot water temperature
 ↗	Multifunction sensor temperature

* The desired temperature is displayed when the OK button is pressed.

- ▷ If a sensor is not connected, the display will show -- --.
- ▷ The display reverts to the standard indication after a few seconds without action.

Set operating mode

The operating mode determines how the heating controller works. Whether the heating system is to be controlled automatically or manually, during a party for example. Or how should the heating system be controlled during longer periods of absence such as holidays?

- ▷ The heating controller leaves the factory with the setting  Standby/OFF. The operating mode must be changed for normal operation.
- 1 Turn selector switch to “Mode”.
 - 2 Press the OK button.

- ▷ Display flashes.
- 3** Set the operating mode using the rotary knob.
- 4** Press OK after you have selected your setting.
- ▷ The new operating mode is displayed.
- 5** Turn selector switch back to **Run**.
- ▷ All operating modes have an effect on the heat source and on both internal heating circuits of the controller. A different mode can be assigned to each heating circuit individually, see page 12 (User – Set parameters).
- ▷ If the controller is used as a heating system controller, all heating circuits of the system are deactivated for operating modes ϕ and F . This only applies to the associated heating circuit when used as a mixer expansion.

Example: Installation with three mixed heating circuits and hot water preparation

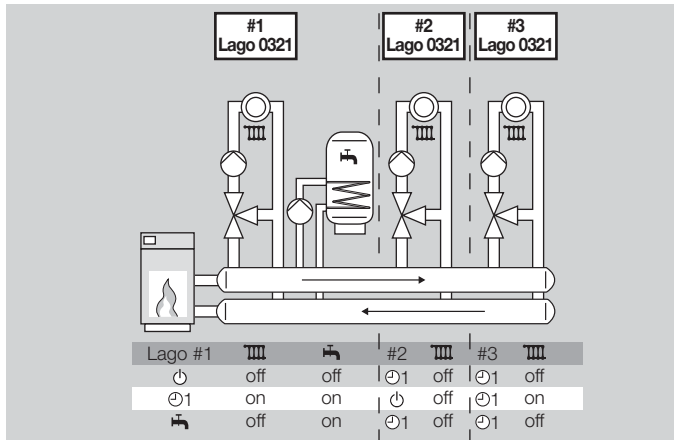

Lago #1 controls the first heating circuit and hot water. Lago #2 controls the second heating circuit and Lago #3 the third. If mode ϕ was selected for Lago #1, the entire system will be switched off, regardless of the settings for the other controllers.

You can set the following operating modes

ϕ Standby/OFF

Heating and hot water preparation are deactivated. Only the frost protection function remains active.

ϕ 1 Automatic mode 1

Heating occurs according to heating program 1: Heating occurs at identical times for Monday–Friday, as well as Saturday–Sunday. Hot water according to parameter 18, see page 11 (Set heating program 1).

ϕ 2 Automatic mode 2

Heating occurs according to heating program 2: You can set Individual heating times for each day. Hot water according to parameter 18, see page 11 (Set heating program 2).

- ▷ Toggling between Automatic mode 1 and 2 can be useful for shift workers. The times do not need to be entered for each shift - they only need to be switched over.

F Day mode

Heating occurs for 24 hours to desired room temperature Day. Hot water according to parameter 18, see page 8 (Set the desired temperature).

This setting is required for events such as a party, when the heating period in automatic mode will not be sufficient. Do not forget to switch back to automatic mode once the party is over.

Night mode (reduced night mode)

Heating is reduced to the setback temperature for 24 hours. Hot water according to parameter 18, see page 15 (P18 Hot water according to program).

This setting can be used to save energy; in exceptional cases when no-one is going to be home during the day over a longer period of time for example. Do not forget to switch back to automatic mode once the party is over.

Summer mode

The heating system is switched off to save energy. Parameter 18 for hot water must be set to 1, 2 or 4, see page 12 (User – Set parameters).

Service

The heat source heats to the max. temperature set in parameter 30. As soon as the temperature of 65 °C has been reached, the consumers regulate to their max. flow temperature for heat removal. Automatic reset after 15 min.

HO Holiday

During holidays the room temperature is regulated to 15 °C.

▷ If parameter 18 is set to 3, hot water preparation is deactivated, see page 15 (P18 Hot water according to program). If parameter 18 is set to 0, 1, 2 or 4, the  HO Holiday mode has no effect on the hot water preparation.

Example: Setting HO Holiday operating mode

You leave on Monday and return Thursday evening. Before leaving on Monday program:

▷ Should you return from your holiday before this time, you will need to set the original operating mode manually.

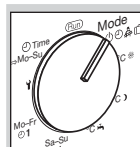

1 Turn selector switch to „Mode“.

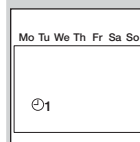

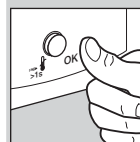

▷ The display shows the current operating mode (e.g. automatic mode 1)

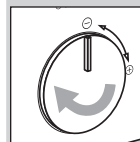

2 Press the OK button.

▷ Display flashes.



3 Rotate the rotary knob clockwise until  HO 4 flashes in the display.

▷ HO 4 indicates that 4 absent days have been programmed (in this example Mon, Tue, Wed and Thu).

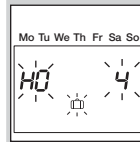

4 Press the OK button.

▷ The display shows  HO 4.

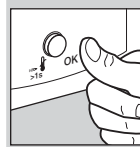

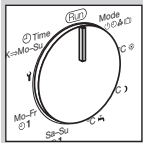

- 5** Turn selector switch back to (Run).
 - ▷ The holiday function starts immediately and ends on Thursday at 24:00. On Friday (day 5) heating mode reverts to the original mode.
 - ▷ Should you return from your holiday before this time, you will need to set the original operating mode again (e.g. automatic mode $\odot 1$).

Set heating program 1

Heating program 1 is assigned to automatic mode $\odot 1$. It is used to define the heating times for the working week (Mo–Fr) and the weekend (Sa–Su). You can set three heating times per day.

- ▷ During heating times the controller heats to desired temperature, between heating times to setback temperature.
- 1** Rotate selector switch to Mo–Fr $\odot 1$ or Sa–Su $\odot 1$.
 - 2** Press the OK button.
 - ▷ The start time of the first heating time flashes.
 - 3** Use the rotary knob to select the start time.
 - 4** Press the OK button.
 - ▷ The end of the first heating time flashes.
 - 5** Use the rotary knob to select the end time.
 - 6** Press the OK button.
 - ▷ Continue with step 3 to set the second and third heating time.
 - ▷ The heating times will only be saved once you have entered all three heating times or have set the start time to “----”.
 - ▷ If you want to delete an existing heating time, use the rotary knob to set the start or end time to “----”.

Example: Indication of the heating times for heating program 1

Heating is to occur from Monday to Friday respectively between 6:00 and 8:00 in the morning, from 11:30 to 13:00 at lunchtime and from 18:00 to 22:00 in the evening.

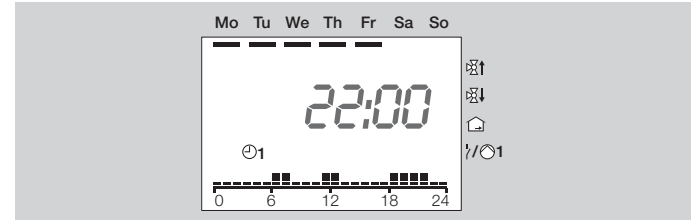

- 7** Finally, turn the selector switch back to (Run).
 - ▷ The heating program 1 has been set. In order to apply it, set the operating mode to “ $\odot 1$ Automatic Mode 1”, see page 8 (Set operating mode).
 - ▷ To cancel the process without saving, turn the selector switch back to (Run) at any time.
 - ▷ Factory setting:
Mo–Fr: 6:00 to 22:00
Sa–Su: 7:00 to 23:00

Set heating program 2

Heating program 2 is assigned to automatic mode $\odot 2$. It can be used to set the heating times for each individual day. You can set three heating times per day.

- ▷ During heating times the controller heats to desired temperature, between heating times to desired temperature Night.
- 1** Turn selector switch to ∇ (Parameter setting).
 - ▷ The display shows PL.

User – Set parameters

- 2** Turn the rotary knob one step in clockwise direction.
 - ▷ The display shows **01** (Monday).
- 3** Press the OK button.
 - ▷ The start time of the first heating time flashes.
- 4** Use the rotary knob to select the start time.
- 5** Press the OK button.
 - ▷ The end of the first heating time flashes.
- 6** Use the rotary knob to select the end time.
- 7** Press the OK button.
 - ▷ Continue with step 3 to set the second and third heating time.
 - ▷ The heating times will only be saved once you have entered all three heating times or have set the start time to "----".
 - ▷ If you want to delete an existing heating time, use the rotary knob to set the start or end time to "----".

Example: see page 11 (Set heating program 1).

- 8** Turn the rotary knob clockwise to the next day: **02** = Tuesday to **07** = Sunday.
 - ▷ Continue with step 3.
- 9** Finally, turn the selector switch back to **(Run)**.
 - ▷ The heating program 2 has been set. In order to apply it, set the operating mode to "02 Automatic Mode 2", see page 8 (Set operating mode).
 - ▷ To cancel the process without saving, turn the selector switch back to **(Run)** at any time.
 - ▷ Factory setting:
Mo–Fr: 6:00 to 8:00, 16:00 to 22:00
Sa–Su: 7:00 to 23:00

Load factory settings (Reset)



- ▷ All personal settings will be lost.
- 1** Take a note of all the settings you have made in these instructions.
 - 2** Switch off mains.
 - 3** When switching the mains back on, keep the OK button pressed until **EE P-** appears in the display.
 - ▷ The factory settings have been loaded.

User – Set parameters

As for heating program 2 you can change further parameters to adapt the heating system to your requirements.

- 1** Turn selector switch to **↓** (Parameter setting).
 - ▷ The display shows **PL**.
- 2** Turn the rotary knob clockwise until the parameter you want to change appears in the left-hand side of the display: **08** to **19** (operating mode direct heating circuit until to display heating program).
 - 3** Press the OK button.
 - ▷ Display flashes.
 - 4** Use the rotary knob to set the desired value.
 - 5** Press the OK button to confirm.
- 6** After you have made the setting, continue with step 2 if you want to change further parameters, or turn the selector switch back to **(Run)**.
 - ▷ The table – see page 13 (List of parameters P01 to P19) – shows the possible settings (including the parameters for heating program 2).
 - ▷ The heating controller will only display those parameters for which there are sensors connected.

List of parameters P01 to P19

P-No.	Parameter	Setting range	Factory setting	Own values
01	Heating program 2 for Monday	00:00–24:00		
02	Heating program 2 for Tuesday	00:00–24:00	06:00–08:00	
03	Heating program 2 for Wednesday	00:00–24:00	16:00–22:00	
04	Heating program 2 for Thursday	00:00–24:00		
05	Heating program 2 for Friday	00:00–24:00		
06	Heating program 2 for Saturday	00:00–24:00	07:00–23:00	
07	Heating program 2 for Sunday	00:00–24:00		
08	Operating mode direct heating circuit (HC1)	----, ☉, ☉1, ☉2, ⚙, ☾	----	
09	Heat slope direct heating circuit	0.20–3.00	1,20	
10	Room sensor influence direct heating circuit	OFF, 0–20	10	
11	Room sensor correction direct heating circuit	-5 to +5 °C	0	
13	Operating mode mixer circuit (HC2)	----, ☉, ☉1, ☉2, ⚙, ☾	----	
14	Heat slope mixer circuit	0.20–3.00	1.20 	
 With underfloor heating set parameter 14 < 1, with radiator heating > 1.				
15	Room sensor influence Mixer circuit	OFF, 0–20	10	
16	Room sensor correction Mixer circuit	-5 to +5 °C	0	
18	Hot water according to program	0 = Off 1 = Heating program 1 2 = Heating program 2 3 = 1 hour before heating 4 = 24 hours hot water	1	
19	Indication of heating program at the lower margin of the display	0 = for direct heating circuit 1 = for mixed heating circuit	0	

Explanation of the parameters

P01 – P07 Heating program 2 (Monday to Sunday)

Heating program 2 is assigned to Automatic mode 2, see page 11 (Set heating program 2).

P08 Operating mode direct heating circuit (HC1)/ P13 Operating mode mixer circuit (HC2)

P08 = ----: The direct heating circuit operating mode corresponds to the value in chapter “Set operating mode”.

P13 = ----: The mixer circuit operating mode corresponds to the value in chapter “Set operating mode”.

A separate and different operating mode can be selected for both circuits individually.

1 = ϕ Standby/OFF

2 = \odot 1 Automatic mode 1

3 = \odot 2 Automatic mode 2

4 = \ast Day mode

5 = \curvearrowright Night mode (reduced night mode)

Exception: The general operating modes ϕ Standby/OFF and \curvearrowright Summer mode have a reducing effect on the entire system. All heating circuits are switched off.

Example: Heating by means of radiators and underfloor heating

In your house you have heaters that supply the direct heating circuit with water, and underfloor heating that heats the mixer circuit. Because underfloor heating acts slower than a radiator, the underfloor heating is to be switched on and off beforehand.

Set the general operating mode “ \odot 1 Automatic mode 1”, see page 8 (Set operating mode).

In order to use different heating times for the mixer circuit, set parameter 13 to \odot 2 = Automatic mode 2.

Now you can use Heating program 1 to set the heating times for your radiators and Heating program 2 to set different times for the floor heating, see page 11 (Set heating program 1) and page 11 (Set heating program 2).

If the floor heating is meant to be switched off, set parameter 13 to ϕ = Standby/OFF.

P09 Heat slope direct heating circuit/

P14 Heat slope mixer circuit

Selecting the correct heat slope saves energy because the heat sources only heat to the point required by the respective outside temperature.

The heat slope specifies the number of °C by which the flow temperature changes when the outside temperature rises or drops.

- ▷ Before you select the heat slope, set the room temperature to the desired value, see page 8 (Set the desired temperature).
 - ▷ Ideally, the heat slope is set when the outside temperature is below 5 °C. Changes to the heat slope setting must be applied in small steps and long intervals (at least 5–6 hours between steps). The system must be allowed to adjust to the new value after each change to the heat slope.
 - ▷ Select the heat slope so that the desired room temperature is achieved with the thermostat valves fully opened, and doors and windows closed.
 - ▷ Increase the heat slope if the desired room temperature is not reached in combination with low outside temperatures.
 - ▷ If the desired room temperature is not reached in combination with high outside temperatures, increase the desired room temperature.
 - Now change the heat slope.
-

- ▷ Typical values:
 floor heating: 0.4 to 0.8
 Radiators: 1.0 to 1.5

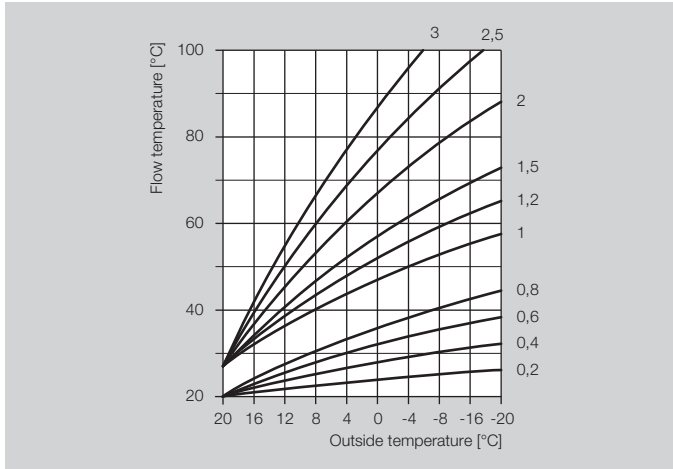

P10 Room sensor influence direct heating circuit/ P15 Room sensor influence mixer circuit

Only active if a room sensor is connected or an FBR2 remote control with integrated room sensor is used. It is possible to adjust the influence of the room sensor on the control process.

- ▷ The higher the set value the greater the influence of the room sensor on the calculated flow temperature.
 P10/15 = OFF: purely weather-guided control
 P10/15 = 0: purely weather-guided control
 P10/15 = 20: pure room temperature control

Within the range 0–20 the heating circuit pump operates up to the next heating time if there is a heating requirement during the period of reduced temperature Night (e.g. frost protection of when the temperature drops below the setback temperature. This prevents the rooms from becoming too cool.

Example: P10/15 = 5

With this setting the desired temperature of the heat source is increased by 5 °C when the room temperature drops below the desired room temperature by 1 °C.

P11 Room sensor correction direct heating circuit/ P16 Room sensor correction mixer circuit

Only active if a room sensor is connected or an FBR2 remote control with integrated room sensor is used. This setting can be used to correct measurement errors of the connected room sensor, e.g. when the room sensor is influenced by incorrect positioning.
 Setting range: P11/16 = -5 to +5 °C

Example: Room sensor correction direct heating circuit

Your room sensor measures 20 °C. A reference thermometer, however, determines 22 °C. Now set parameter 11 = 2 so that the value 2 °C is added to the measured value.

P18 Hot water according to program

This parameter can be used to define the heating times for hot water.
 P18 = 0: Off (no hot water preparation)
 P18 = 1: hot water in line with heating program 1
 P18 = 2: hot water in line with heating program 2
 P18 = 3: 1 hour before the heating times of automatic mode 1 or 2.
 (The desired automatic mode is set via the operating mode.
 With activated  HO Holiday mode the hot water preparation is not switched on.)

With the mode “Summer mode” parameter 18 must be set to 1, 2, or 4.

P18 = 4: 24 hours hot water

Example: P18 = 3

If “Automatic mode ①” was selected as the operating mode, the heating controller will always switch on the hot water one hour before switching on the heating. If  HO Holiday mode is activated, the hot water is not switched on.

P19 Indication of heating program at the lower margin of the display

P19 = 0: The heating program for the direct heating circuit is displayed.

P19 = 1: The heating program for the mixed heating circuit is displayed.

User – Questions

How do I switch to summer/winter time?

To switch from summer to winter time and vice versa you need to reset the time, see page 8 (Set time and day of the week).

How do I set the heating controller so that it gets warm sooner in the morning?

There are two heating programs to set the heating times.

Heating program 1 for setting the heating times Mo–Fr (working week) and Sa–Su (weekend) for the week as a whole,

Heating program 2 for setting the heating times for each day of the week Mo, Tu, We, Th, Fr, Sa and Su.

Heating program 1 in operating mode ① is assigned to automatic mode 1.

Heating program 2 in operating mode ② is assigned to automatic mode 2.

First select automatic mode ① or ②, see page 8 (Set operating mode).

Then adjust the associated heating program to suit your needs, see page 11 (Set heating program 1) or 11 (Set heating program 2).

My heater does not get warm enough. What can I do?

You have two options.

First increase the desired room temperature Day, see page 8 (Set the desired temperature).

Wait for a few hours to give the heating system time to respond to the new setting.

Should the room(s) still not get warm enough, you can increase the heat slope for the direct heating circuit or the mixer circuit, see page 14 (P09 Heat slope direct heating circuit/ P14 Heat slope mixer circuit).

Should this measure not be sufficient, see page 47 (Help with faults) and contact your heating engineer.

How do I set the heating system for holidays?

If you want to go away for a number of days, you can set the heating controller to the operating mode “HO Holiday”. The heating system will revert to automatic mode at the end of the holiday so that it will be warm when you come home, see page 8 (Set operating mode).

How can I switch the heating system off during the summer?

In summer you should set the heating controller to the operating mode “Summer mode”. This mode deactivates heating and the system is only used for hot water, see page 8 (Set operating mode).

Is it possible to let the heating system run longer in the evening for special occasions such as a party?

For this purpose select the operating mode “* Day mode”, see page 8 (Set operating mode).

How do I set the heating controller to save energy?

- ▷ Set the desired room temperature only as high as absolutely necessary. The energy consumption is increased by around 6% for every degree, see page 8 (Set the desired temperature).
- ▷ Set your heating program so that it switches the heating off at night or at times when no-one is home.
- ▷ Only open your windows briefly to let in fresh air. Avoid tilted windows over longer periods.

Which room is allocated to which heating circuit?

Please contact your heating engineer to answer this question. You will find a table on the last page of these instructions where these allocations can be entered.

My heating system is not running

Check the selector switch position. The selector switch must be set to **(Run)**.

Check the operating mode. The display must indicate 1 for Automatic mode 1, or 2 for Automatic mode 2, see page 8 (Set operating mode).

Expert - Installation

! CAUTION

The minimum distance from surrounding heat sources is to be chosen so that the permitted ambient temperature will not be exceeded during operation, see page 49 (Technical data).

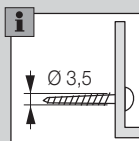
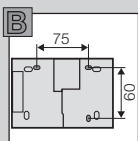
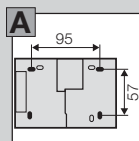
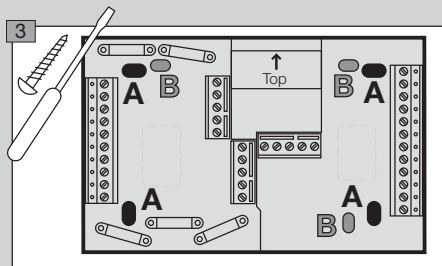
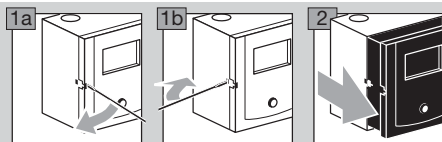

Expert - Electrical connections

⚠ WARNING

Possible life-endangering electrical shock! Switch the power off to electrical cables before working on power-carrying parts!

! CAUTION

For fixed devices, an isolating mechanism must be installed for shutting off from the network, in accordance with the installation guidelines and EN 60335, e.g. with a switch.

The insulation for line conductors is to be protected against damage by overheating, e.g. insulating sleeve.

Define application

The Lago 0321 can be used for three different applications: as a heating system controller, as a mixer expansion, or as a controller for a heat source (boiler control) in a cascade.

The application is determined automatically by connecting certain sensors and on setting specific parameters.

Heating system controller

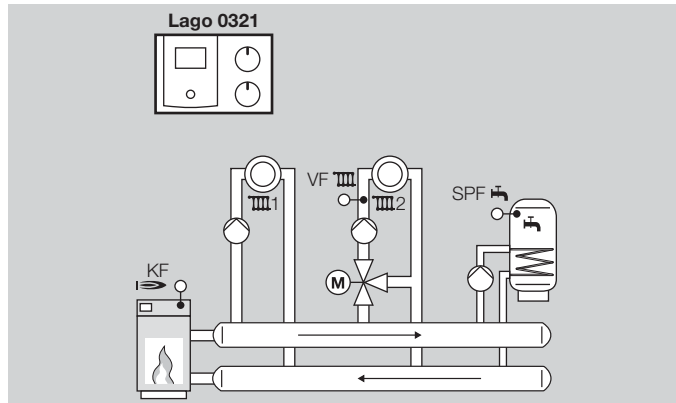

Connect heat source sensor (KF/KFS), flow sensor (VF/VFAS) and storage sensor (SPF/SPFS),

Parameter 38 = “----” (no heating module address)

The following functions are now active:

- ▷ control of a single-stage heat source or an alternative heat removal from a buffer storage tank,
- ▷ control of a hot water preparation system,
- ▷ control of a mixed heating circuit,
- ▷ control of a direct heating circuit or, alternatively, an additional function with multifunction relay, such as a circulation pump, return flow temperature increase or header pump. (For this purpose, set the DIP switches and parameters 80–82. Additional sensors may be required.)

Controller for a mixed heating circuit as expansion for a heating system controller

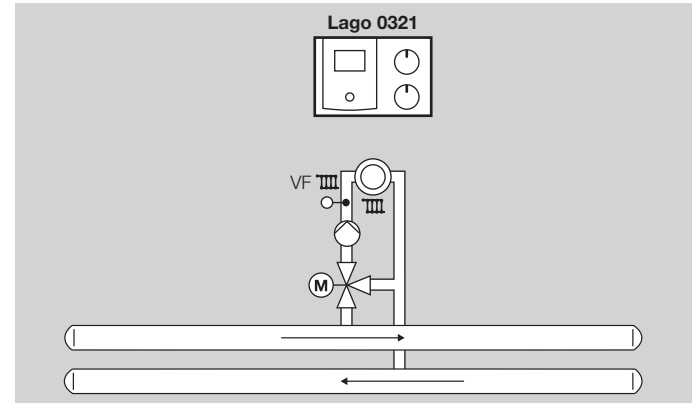

This application is automatically activated if only one flow sensor (VF/VFAS) is connected.

Set parameter 23 to heating circuit address (2–15).

The following functions are now active:

- ▷ Control of an additional mixed heating circuit (expansion for a heating system controller), e.g. in a multi-family unit.
- ▷ Control of an additional function with multifunction relay, e.g. circulation pump or return flow booster. (For this purpose, set the DIP switches and parameters 80–82.)

The following functions can not be used:

- ▷ Header pump
- ▷ Heat source pump

Controller for a heat source in a cascade: Heating module

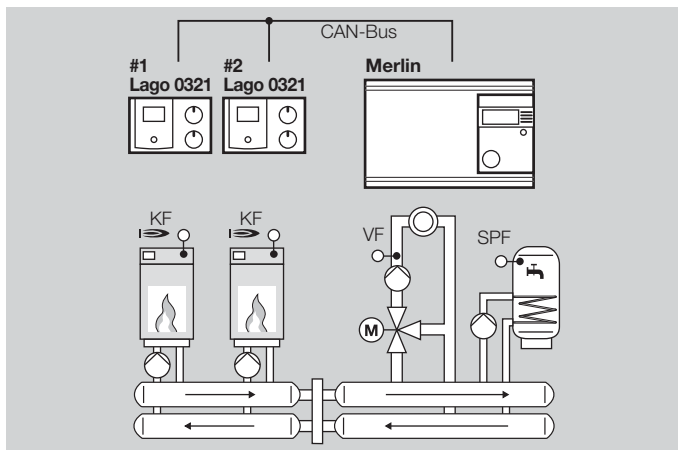

This application is automatically activated as soon as you connect a heat source sensor (KF/KFS) and set parameter 38 = 1–8 (heating module address).

The following functions are now active:

- ▷ Control of a heat source in a cascade,
- ▷ Control of an additional function with multifunction relay, e.g. heat source pump or return flow booster.
- ▷ A cascade manager, such as Merlin 5064, is required for heating circuit and hot water control.

Connection diagram controller without socket

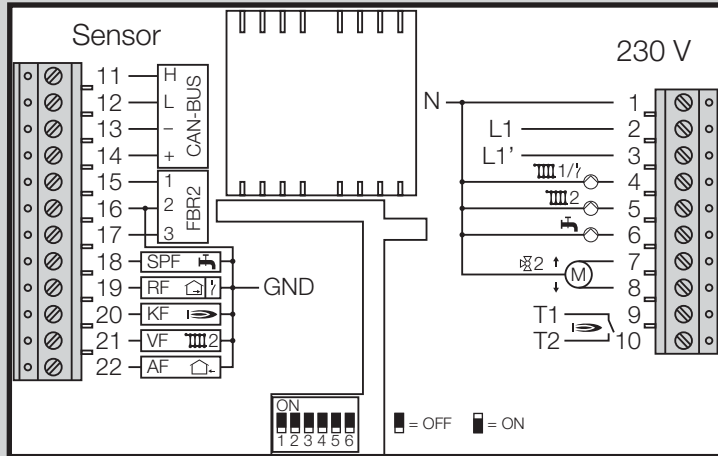

- ▷ Use solid lines or flexible lines with wire end sleeves for connections (230 V).
- ▷ Route CAN bus lines and sensor lines separately from power lines.
- ▷ Never mix 1 kΩ and 5 kΩ sensors.
- ▷ Only connect sensors required for the system.
- ▷ Connect a bridge between terminal 16 and GND bus terminal. If the bridge between terminal 16 and GND is omitted, the sensor values will not be displayed.
- ▷ Set bridge and reset heating controller.

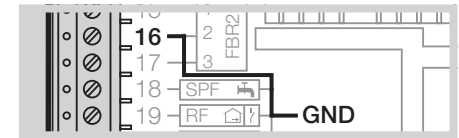

SELV, safety extra low voltage		230 V~, switching capacity of the relays 2 A, 250 V~	
11–14	CAN-BUS	1	Neutral conductor mains
15–17	FBR2, alternatively:	2	Mains voltage heating controller L1
15–16	Room thermostat	3	Mains voltage for the outputs L1'
16–17	Phone switch	4	Pump heating circuit 1 or multifunction relays
18	Storage sensor	5	Pump heating circuit 2
19	Room sensor or multifunction sensor	6	Storage charging pump
20	Boiler sensor	7	Mixer Open
21	Flow sensor	8	Mixer Close
22	Outdoor sensor	9–10	Burner electrically isolated

- ▷ Use solid lines of flexible lines with wire end sleeves for connections (230 V).
- ▷ Route bus lines and sensor lines separately from power lines.
- ▷ Never mix 1 kΩ and 5 kΩ sensors.

Connection diagram controller with socket

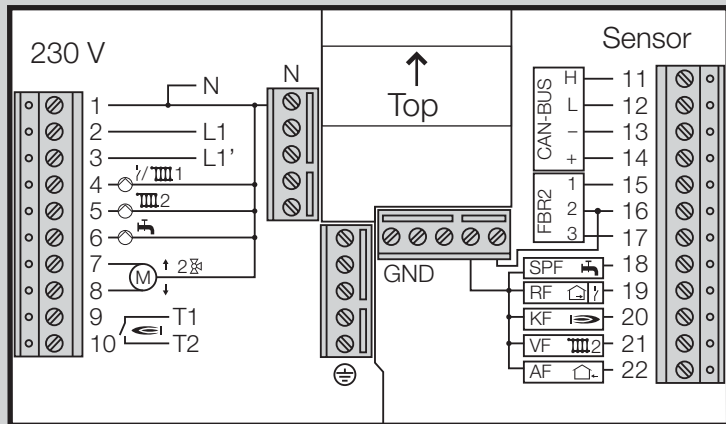

- ▷ Use solid lines or flexible lines with wire end sleeves for connections (230 V).
- ▷ Route CAN bus lines and sensor lines separately from power lines.
- ▷ Never mix 1 kΩ and 5 kΩ sensors.
- ▷ Only connect sensors required for the system.
- ▷ Connect a bridge between terminal 16 and GND bus terminal. If the bridge between terminal 16 and GND is omitted, the sensor values will not be displayed.
- ▷ Set bridge and reset heating controller.

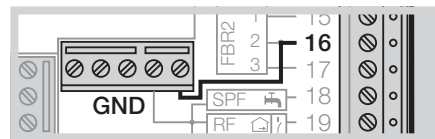

230 V~, switching capacity of the relays 2 A, 250 V~	SELV, safety extra low voltage
1 Neutral conductor mains	11–14 CAN-BUS
2 Mains voltage heating controller L1	15–17 FBR2, alternatively:
3 Mains voltage for the outputs L1'	15–16 Room thermostat
4 Pump heating circuit 1 or multifunction relays	16–17 Phone switch
5 Pump heating circuit 2	18 Storage sensor
6 Storage charging pump	19 Room sensor or multifunction sensor
7 Mixer Open	20 Boiler sensor
8 Mixer Close	21 Flow sensor
9–10 Burner electrically isolated	22 Outdoor sensor

Options

Provided no separate regulations for protecting the relay apply, a bridge to supply the relay must be connected between terminals 2 and 3.

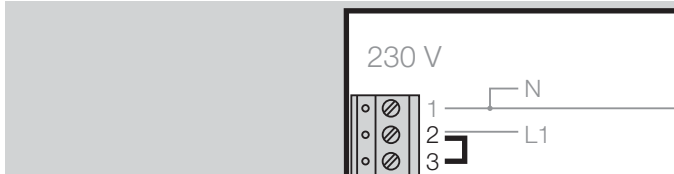

Maximum limiter



If a maximum limiter is required for the mixed heating circuit, e.g. in combination with underfloor heating, the limiter must be connected between terminal 5 and the heating circuit pump.

Examples of installations

Heating system controller for heat source, mixed heating circuit and hot water preparation

Requirements

In the condition as supplied to the customer the heating controller can be used for this system, provided the required sensors are connected.

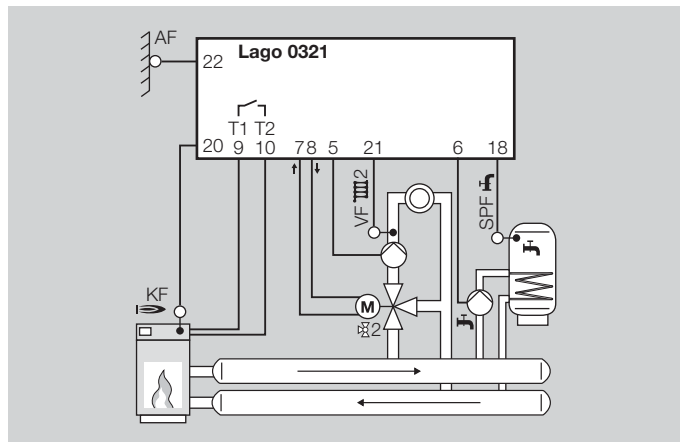

Sensors, see page 43 (Accessories)

- ▷ AF/AFS external sensor: only with atmospheric control
- ▷ KF/KFS boiler sensor: in combination with heat source control
- ▷ VF/VFAS flow sensor: only with mixed heating circuit
- ▷ SPF/SPFS storage sensor.

Room control

The room temperature can be detected and controlled as follows:

- ▷ FBR2 Remote control with room sensor,
- ▷ RFB Room sensor on terminals 15+16,
- ▷ Lago FB, BM8 or Merlin BM operating module, connected via a CAN-BUS (Terminals 11 – 14).

Set parameters

P14, P18, P19 and P70

The factory settings apply for all other parameters, see page 32 (Expert – Set parameters).

Set DIP switches



See page 31 (Expert – Set DIP switches) for explanation.

Heating system controller for mixed heating circuit and hot water preparation from a buffer storage tank

Requirements

In the condition as supplied to the customer the controller can be used for this system, provided the required sensors are connected.

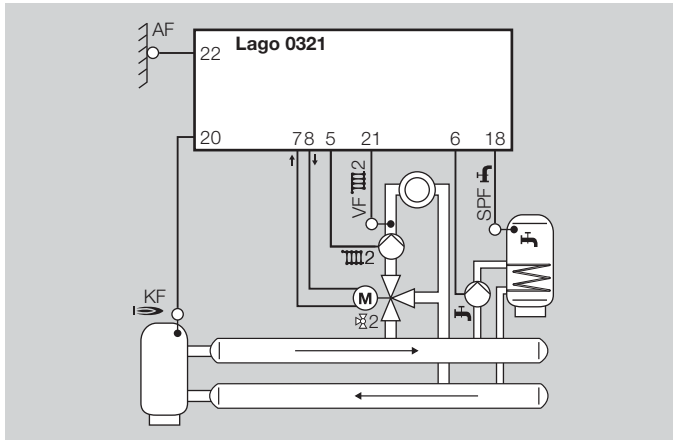

Sensors, see page 43 (Accessories)

- ▷ AF/AFS external sensor: only with atmospheric control
- ▷ KF/KFS boiler sensor: If the KF/KFS sensor is connected, the heating circuit pump and the storage charging pump will only be switched on when the Warm Up Temperature is exceeded at this sensor. The storage charging pump is only activated when the heat source temperature (KF/KFS) is also higher than the hot water temperature (SPF/SPFS).

- ▷ If no heat source sensor (KF/KFS) is installed, the heating controller will show "--" for nothing to display.
- ▷ VF/VFAS flow sensor: only with mixed heating circuit
- ▷ SPF/SPFS storage sensor

Room control

The room temperature can be detected and controlled as follows:

- ▷ FBR2 Remote control with room sensor,

Set parameters

P14, P18, P19, P32, P50, P52, P53 and P70

The factory settings apply for all other parameters, see page 32 (Expert – Set parameters) for explanations.

Set DIP switches

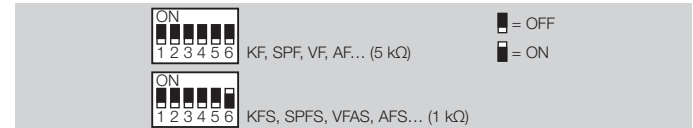

See page 31 (Expert – Set DIP switches) for explanation.

Additional functions with multifunction relay

The multifunction relay (terminal 4) can be used for additional functions.

- ▷ DIP switch 4 = "OFF" (Multifunction relay activated)

Circulation pump,
parameters 80
= 02

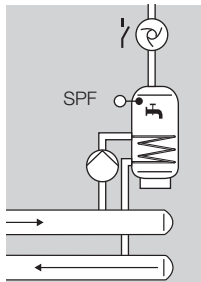

Pump heat source
1, P80 = 05

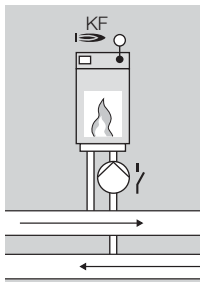

Return flow
booster, P80 = 24

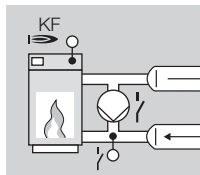

Set P81 and P82
according to boiler
manufacturer's
specifications

Heating system controller for direct heating circuit, mixed heating circuit and hot water preparation

Requirements

- ▷ DIP switch 4 = "ON" (direct heating circuit)
- ▷ Set parameter 23 = Address 2-15 for the mixed heating circuit.

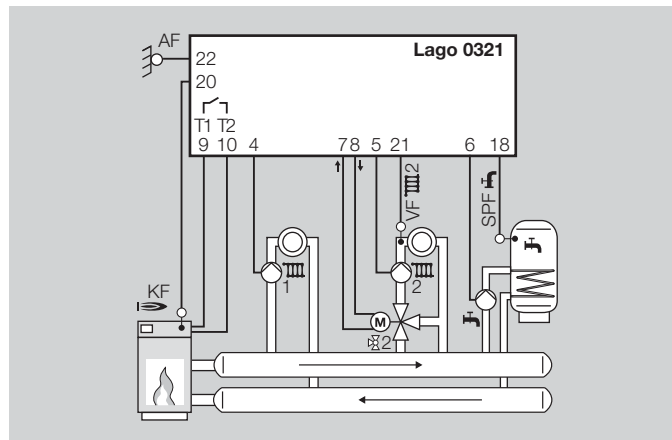

Sensors, see page 43 (Accessories)

- ▷ AF/AFS external sensor: only with atmospheric control
- ▷ KF/KFS boiler sensor: in combination with heat source control
- ▷ VF/VFAS flow sensor: only with mixed heating circuit
- ▷ SPF/SPFS storage sensor

Room control

The room temperature can be detected and controlled as follows:

- ▷ FBR2 remote control with room sensor, Assign the desired heating circuit using DIP switch 5.

- ▷ If a second room sensor is connected to terminal 19, it automatically affects the other heating circuit.

Set parameters

P9, P14, P18, P19, P30, P31, P32, P50, P51, P52, P60 and P70
 The factory settings apply for all other parameters, see page 32 (Expert – Set parameters) for explanations.

Set DIP switches

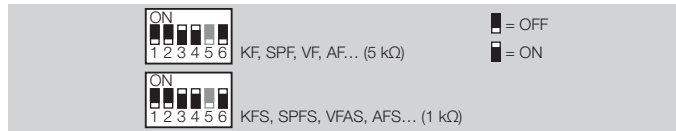

If a remote control is connected, set DIP switch 5:

- ▷ DIP switch 5 = “ON”: Remote control with room sensor FBR2 for direct heating circuit,
- ▷ DIP switch 5 = “OFF”: Remote control with room sensor FBR2 for mixer circuit.

See page 31 (Expert – Set DIP switches) for explanation.

Controller for a mixed heating circuit as expansion for a heating system controller

Requirements

- ▷ This application is automatically activated if only one flow sensor (VF/VFAS) is connected.
- ▷ Set parameter 23 = Address 2–15 for the mixer circuit to be controlled. This address must not be assigned to another heating circuit.

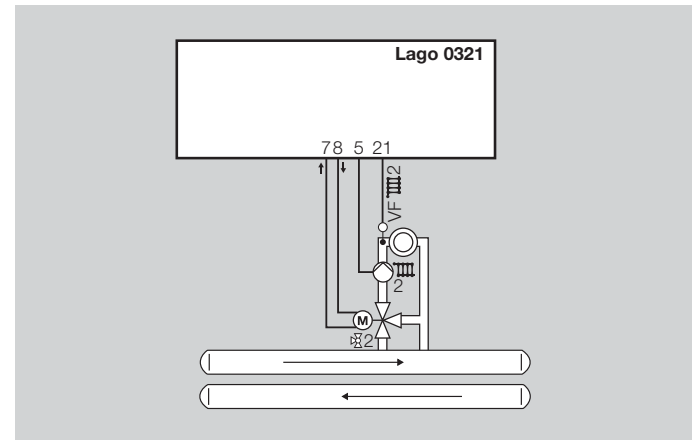

Sensor

- ▷ VF/VFAS flow sensor: for the mixer circuit.

Set parameters

P14, P19 and P70

The factory settings apply for all other parameters, see page 32 (Expert – Set parameters) for explanations.

Set DIP switches

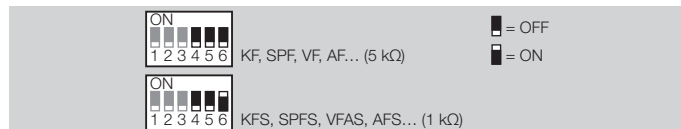

See page 31 (Expert – Set DIP switches) for explanation.

Additional functions with multifunction relay

The multifunction relay (terminal 4) can be used for additional functions.

▷ DIP switch 4 = “OFF” (Multifunction relay activated)

Circulation pump,
parameters 80
= 02

Feed pump 1,
P80 = 03

Return flow
booster, P80 = 24

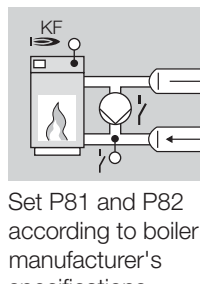
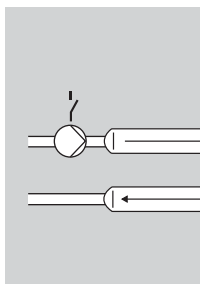
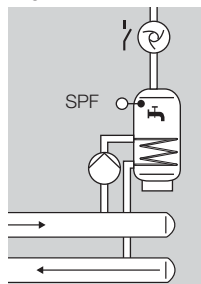

Controller for a heat source in a cascade: Heating module

Requirements

This application is automatically activated when

- ▷ a heat source sensor (KF/KFS) is connected and
- ▷ parameter 38 is assigned an address 1 to 88 (address heating module).

The heating controller controls “his” heat source according to the requests from the cascade controller.

The internal mixer circuit can be used should the mixer circuits controlled by the cascade controller (e.g. Merlin) be insufficient. In this case, parameter 23 for the internal mixer circuit must be set to an address 1–15.

Sensors, see page 43 (Accessories)

- ▷ KF/KFS boiler sensor
- ▷ VF/VFAS Flow sensor (only with use of the internal mixer circuit)

The multifunction relay controls the heat source pump.

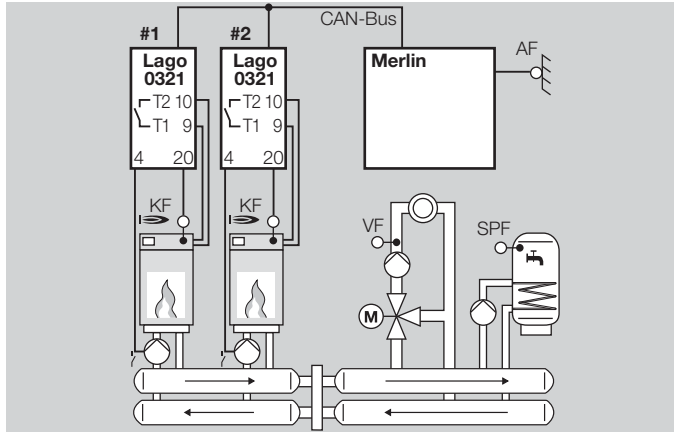

Set parameters

P30, P31, P32, P38, P80 = 5

The factory settings apply for all other parameters, see page 32 (Expert – Set parameters) for explanations.

Set DIP switches



See page 31 (Expert – Set DIP switches) for explanation.

The multifunction relay controls the return flow booster.

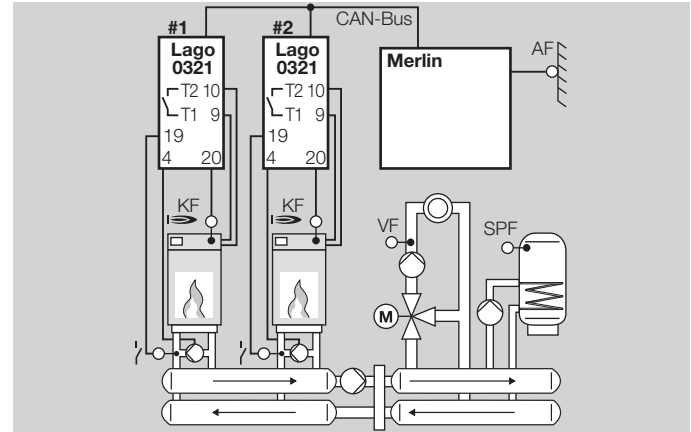

Set parameters

P30, P31, P32, P38, P80 = 24, P81 and P82

The factory settings apply for all other parameters, see page 32 (Expert – Set parameters) for explanations.

Set DIP switches

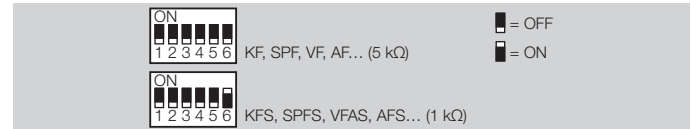

See page 31 (Expert – Set DIP switches) for explanation.

Internal hot water preparation of the first heat source in the cascade (hydraulic separation)

Requirements

This mode of operation is automatically activated when

- ▷ a heat source sensor (KF/KFS) is connected and
- ▷ parameter 38 is assigned an address 1 to 88 (address heating module).

In this application the relay for the hot water charging pump is used for controlling the three-way valve for switching the heat source to the hot water storage tank. The multifunction relay controls the heat source pump.

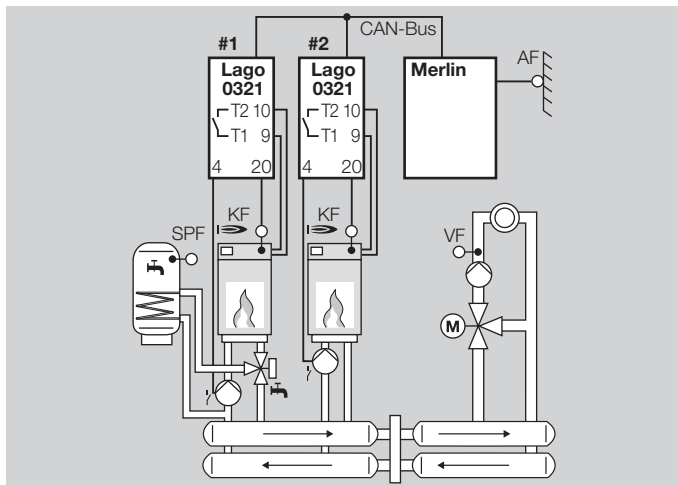

Set parameters

P30, P31, P32, P38, P80 = 05

The factory settings apply for all other parameters, see page 32 (Expert – Set parameters) for explanations.

Set DIP switches



See page 31 (Expert – Set DIP switches) for explanation.

Expert – Set DIP switches

= OFF = ON

- ▷ The DIP switches 1 – 3 are now without function. The heating circuit address of the mixer circuit is set via parameter 23, see page 34 (P23 CAN bus ID mixer circuit (heating circuit address)).

Direct heating circuit or multifunction relay

The output on terminal 4 can be switched over between “Pump direct heating circuit” and “Multifunction relay”.

- Use DIP switch 4.

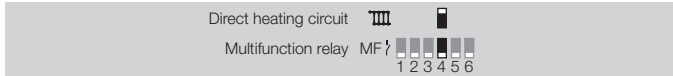

- ▷ If terminal 4 is to be used for the direct heating circuit pump, set the heating circuit address 2 or higher for the mixer circuit because the direct heating circuit occupies address 1.

Assigning a remote control FBR2 to the direct heating circuit or mixer circuit

A connected remote control FBR2, a connected room sensor or room thermostat can be assigned to the direct heating circuit or the mixer circuit if the system is operated with two heating circuits.

- Use DIP switch 5.

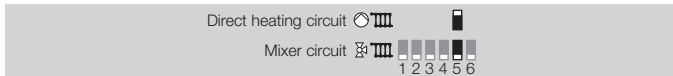

Set sensor resistance

The heating controller can be operated with 5 kΩ or 1 kΩ sensors.

- Use DIP switch 6.

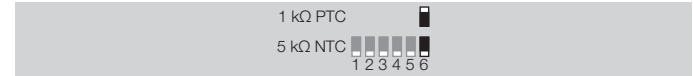

- ▷ Only sensor of one type may be used.

Expert – Set parameters

- ▷ Parameters P1 to P19 for User, see page 12 (User – Set parameters)

WARNING

Incorrect settings can cause malfunctions and damage the heating installation! Only a qualified expert may change the parameters from no. 21.

- ▷ A code number must be entered via parameter P20 to change parameters P21 and higher.

1 Turn selector switch to  (Parameter setting).

- ▷ The display shows *PL*.

2 Turn the rotary knob until the parameter you want to change or retrieve appears on the left in the display: *21* to *99*.

3 Press the OK button.

- ▷ The indicator jumps to *20 0000*. The first digit flashes.

4 Enter code no. (factory setting is 0000).

- ▷ Set each digit with the rotary knob and press the OK button.

- ▷ The display jumps back to the parameter to be changed.

- ▷ Display flashes if the correct code no. was entered. (The display does not flash if the code no. was not entered correctly. Continue with step 3.)

5 Use the rotary knob to set the desired value.

- ▷ A number of parameters can only be displayed.

6 Press the OK button to confirm.

7 After you have made your settings, continue with step 2 if you want to change further parameters (you do not need to enter the code no. again), or turn the selector switch back to .

- ▷ The table on page 33 (List of parameters P20 to P99) shows the possible settings.

- ▷ Our heating controller will only display those parameters for which there are sensors connected.

List of parameters P20 to P99

P. no.	Parameter	Setting range	Factory setting	Own values
20	Code no. input	0000–9999	0000	
21	Code no.	0000–9999	0000	
22	Outside temperature Frost protection	----, -15.0 to +5.0 °C	0.0 °C	
23	CAN bus ID mixer circuit	1–15 (2–15 with direct heating circuit)	2	

With active heat source (HS) (boiler module/heating module)

30	Maximum temperature HS	30.0–110.0 °C	85.0 °C	
31	Minimum temperature HS	10.0–80.0 °C	40.0 °C	
32	Warm Up Temp	10.0–80.0 °C	35.0 °C	
33	Minimum limiter HS	0, 1, 2	1	
34	Dyn. switching hysteresis	5.0–20.0 °K	10.0 °K	
35	Hysteresis time	0–30 min	0 min	
36	Burner starts	Display only		
37	Burner running time	Display only		
38	Address heating module (only for cascade operation)	----, 1–8	----	

With active hot water function

50	DHW Relief	0, 1	1	
51	Parallel pump operation	0, 1	0	
52	Antilegion function	0, 1	1	
53	Temperature increase during hot water preparation	0.0–50.0 °K	20.0 °C	

With active direct heating circuit

60	Maximum flow temperature direct heating circuit	20.0–110.0 °C	80.0 °C	
61	Minimum flow temperature direct heating circuit	10.0–110.0 °C	10.0 °C	

P. no.	Parameter	Setting range	Factory setting	Own values
--------	-----------	---------------	-----------------	------------

With active mixer circuit

69	Additional mixer functions (P77–79)	0, 1	0	
70	Maximum flow temperature mixer circuit	20.0–110.0 °C	80.0 °C 	

 With underfloor heating, set parameter 70 according to manufacturer's specifications.

71	Minimum flow temperature mixer circuit	10.0–110.0 °C	10.0 °C	
72	Mixer Dynamic OPEN	5.0–25.0 (P69=1: 5.0–200.0)	16.0 (P69=1: 50)	
73	Mixer Dynamic CLOSED	5.0–25.0 (P69=1: 5.0–200.0)	12.0 (P69=1: 20)	

In combination with heating system controllers with active cooling function

74	T-Flow Cooling	0, 1, 15.0–25.0 °C	15.0 °C	
75	T-Room Cooling	----, 20.0–40.0 °C	25.0 °C	
76	Min TO Cooling	----, 0.0–40.0 °C	27.0 °C	

P77–79 can only be adjusted if P69 = 1

77	Mixer scan time	10–200 s	100 s	
78	Mixer operating time limit	----, 0–30 min	----	
79	Mixer start seconds	0–30 s	0 s	

With multifunction relay (MF Relay)

80	MF Relay function	0–34	0	
81	MF Relay switching temperature	30.0–90.0 °C	30.0 °C	
82	Hysteresis of the MF Relay	2.0–10.0 °K	5.0 °K	

Service

97	PC enable (0000 = disabled)	0000–9999	0000	
98	Relay Test	0, 1–6	0	
99	Software version and index (63.XX)	63.00–63.99	Display only	

Explanation of the parameters

P20 Code no. input

Here the code number defined via P21 is entered for adjustment of the Expert parameters.

▷ The factory setting for the heating controller is 0000.

P21 code no. change

Here you can specify your own code no. Remember this code well! The parameters 21–99 can not be changed without this code no. Should you forget the code no., the factory settings must be re-loaded, and this means that all your settings will be lost, see page 12 (Load factory settings (Reset)).

● Change every digit of the four-digit code no. and confirm by pressing the OK button.

P22 Outside temperature frost protection

P22 = ----: Frost protection is deactivated.

P22 = -15.0 to +5.0 °C: When the outside temperature drops below the set value, the heating circuit controller switches the heating circuit pumps on.

P23 CAN bus ID mixer circuit (heating circuit address)

P23 = 1–15: It is possible to assign an address from 1 to 15 to the mixer circuit. If the direct heating circuit is activated via DIP switch 4, you must set an address of 2–15 for the mixer circuit because the direct heating circuit automatically receives the address 1.

▷ Do not assign a heating circuit address more than once.

▷ When replacing a controller, always set the same address as the original controller.

With active heat source (boiler module/heating module)

P30 Maximum heat source temperature

P30 = 30.0–110.0 °C: The heat source is heated to the maximum of P30.

▷ Protects the heat source from overheating and prevents triggering the Safety-Temperature-Limiter (LIMITER).

▷ Limiting the maximum temperature saves energy.

▷ Also has an effect on the hot water preparation.

▷ Settings according to boiler manufacturer's specifications.

P31 Heat source minimum temperature

P31 = 10.0–80.0 °C: Set the parameter so that the formation of condensation is prevented in the heat source when there is a low heating requirement. The heat source does not switch off before P31 + Switching hysteresis (P34) has been reached when heating up.

▷ Settings according to boiler manufacturer's specifications.

P32 Warm-Up Temp

P32 = 10.0–80.0 °C: The heating controller switches the heating circuit pumps off and closes the mixer until the heat source has reached the temperature P32 when heating up.

▷ This reduces operation within the condensation range.

▷ Settings according to boiler manufacturer's specifications.

P33 Minimum limit heat source

Reduces the formation of condensation in the heat source when there is a low heating requirement. The heating controller does not switch off before the minimum temperature (P31) + Switching hysteresis (P34) has been reached.

P33 = 0: The minimum limit is switched off.

P33 = 1: The heat source maintains at least the set minimum temperature (P31) + Switching hysteresis (P34) during any heating time.

P33 = 2: The heat source maintains at least the set minimum temperature (P31) + Switching hysteresis (P34) for 24 hours (including setback mode times).

P34 Dynamic switching hysteresis

P34 = 5.0–20.0 °C: The switching hysteresis is added to the Minimum Temperature (P31) of the heat source to calculate the actual switch-off value.

P35 Hysteresis time

This function optimises heat source operation when subjected to varying loads.

P35 = 0: The switching hysteresis (P34) is not reduced.

P35 = 1–30 min: The switching hysteresis (P34) is reduced to a hysteresis of 5 °C after the heat source is switched on and P35 has elapsed.

- ▷ When there is little removal of heat, set a long period for P35. This prevents frequent pulsing of the heat source.
- ▷ Set a short period for P35 when there is a high removal of heat. This avoids heating up the heat source to unnecessarily high temperatures. The energy consumption of the heating system is optimised.

Example: Hysteresis time

P34 = 15, P35 = 10

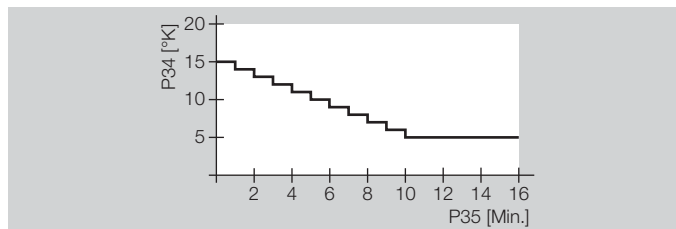

The initial switching hysteresis is reduced from 15 °C to 5 °C after 10 minutes.

P36 Burner starts

P36 shows the number of burner starts (no setting possible).

P37 Burner operating time

P37 shows the entire burner operating time in hours (no setting possible).

P38 Address heating module (only for cascade operation)

P38 = ----: individual heat source (no cascade)

P38 = 1–8: In a cascade the heating controller is addressed under the address specified.

With active hot water function

P50 DHW Relief (charging pump lock)

P50 = 0: The charging pump lock is switched off.

P50 = 1: The heating controller only switches the storage charging pump on when the heat source temperature exceeds the storage temperature by 5 °C. The controller switches the pump off as soon as the heat source temperature drops below the storage temperature.

- ▷ This prevents the storage from being cooled by the heat source at the beginning of hot water preparation.

P51 Parallel pump operation

P51 = 0: Hot water priority mode; During hot water preparation the heating circuit pumps switch off the mixer valves close.

P51 = 1: Parallel pump operation; During hot water preparation the heating controller only disables the direct heating circuit. The mixer circuit continues to be heated.

- ▷ This function extends hot water preparation.

P52 Antilegion function

P52 = 0: Protective function switched off.

P52 = 1: As a protective measure against thermoresistant bacteria, the hot water storage tank is heated to 65 °C with every 20th heating-up process or at least once per week on Saturday at 01:00.

P53 Temperature increase during hot water preparation

P53 = 0.0–50.0 °C: The heat source is operated at increased temperature during hot water preparation to ensure that the hot water temperature is reached quickly via the heat exchanger.

- ▷ The heat source desired temperature during hot water preparation = Desired hot water temperature + P53.

With active direct heating circuit

P60 Maximum flow temperature direct heating circuit

P60 = 20.0–110.0 °C: The heating controller limits the calculated desired flow temperature of the direct heating circuit to P60 to protect the consumer from overheating.

- ▷ Only when the temperature of the heat source exceeds P60 by 8 °C does the heating controller switch off the heating circuit pump of the direct heating circuit. The controller will switch the heating circuit pump back on as soon as the heat source temperature drops below P60 + 5 °C.

P61 Minimum flow temperature direct heating circuit

P61 = 10.0–110.0 °C: The heating controller increases the calculated desired flow temperature of the direct heating circuit to P61, when air heating is installed for example.

With active mixer circuit

P69 Additional mixer functions (P77–79)

P69 = 0: The additional mixer functions (P77–79) are deactivated. Instead, the mixer is operated with default settings. This means that the heating controller computes a correction value for the mixer position every 10s (scan time).

- ▷ Settings when motor-driven roller wheel mixers are used.

P69 = 1: P77–79 can be set.

- ▷ Settings when motor-driven lifting valves are used.

P70 Maximum flow temperature mixer circuit

P70 = 20.0–110.0 °C: The heating controller limits the calculated desired flow temperature of the mixed heating circuit to P70 to protect the consumer from overheating, e.g. when an underfloor heating system is installed.

P71 Minimum flow temperature mixer circuit

P71 = 10.0–110.0 °C: The heating controller increases the calculated desired flow temperature of the mixed heating circuit to P71, e.g. when air heating is installed.

P72 Mixer Dynamic OPEN (when opening)/

P73 Mixer Dynamic CLOSED (when closing)

P72/73 = 5.0–25.0 (when P69 = 1; 5.0–200.0):

The Mixer Dynamic determines the ratio between switch-on and switch-off times of the mixer when opening or closing the mixer. Depending on the deviation between desired and actual flow temperature, the mixer is actuated for a longer or a shorter period. The ratio is based on a scan rate of 10s.

- ▷ Lower values cause fast mixer movement and can result in vibration.

Example: Mixer Dynamic OPEN

P72 = 8

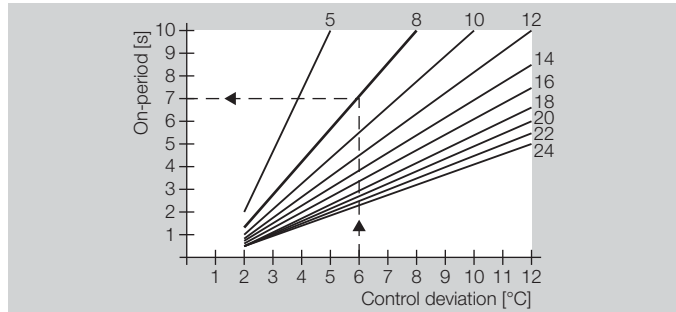

In the case of a controller deviation of 6 °C the mixer is actuated for 7s and remains switched off for 3s.

In combination with heating system controllers with active cooling function

As a requirement for cooling mode, the central controller (e.g. Merlin) must activate the “Cooling” operating mode.

74 T-Flow Cooling (flow temperature Cooling)

P74 = 0: The heating circuit is not cooled. The mixer in the heating circuit remains closed, the heating circuit pump is switched off.

P74 = 1:

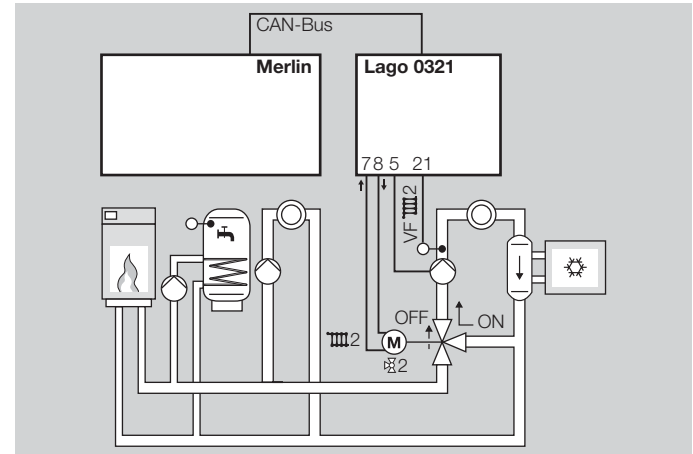

The mixer in the heating circuit functions as a valve. The mixer opens (ON). The heating circuit pump is switched on. P74 = 10.0 – 25.0 °C: The mixer controls to the set flow temperature P74 of the heating circuit, see page 38 (Example: Cooling Operation).

P75 T-Room Cooling (desired room temperature)

Room temperature guided cooling

P75 = ----: The heating controller does not control according to desired room temperature.

P75 = 20.0–40.0 °C: The heating controller starts cooling mode of operation as soon as the temperature exceeds the set desired room temperature P75. Cooling mode ends when the temperature drops below P75 by 2 °C.

P76 Min TO Cooling (Minimum outside temperature for cooling)

Weather-guided cooling

P79 Mixer start seconds

P79 = 0–30 s: The first stroke of a closed mixer does not immediately effect a change in the flow temperature. P79 is the time that elapses until a change in flow temperature can be measured.

- ▷ Increase this value if the flow temperature changes too slowly during the initial stage.

With multifunction relay (MF Relay)

The multifunction relay (terminal 4) is active with the setting DIP switch 4 = “OFF”. The sensor on terminal 19 is assigned to the relays.

P80 MF Relay function

P80 = 0: without function

P80 = 1: Header pump (only when the Lago 0321 is used as a heating system controller)

- ▷ The header pump is switched on when a consumer requests heat.
- ▷ When there is no heat request, the pump is switched off. The pump runs on for 5 minutes after the heat source has been switched off.

P80 = 2: The circulation pump is switched on simultaneously with the hot water program.

- ▷ A storage sensor must be installed in the system.

P80 = 3: Feed pump

- ▷ The feed pump is switched on when an internal consumer requests heat.
- ▷ When there is no heat request, the pump is switched off. The pump runs on for 5 minutes after the heat source has been switched off.

P80 = 5: Heat source pump

- ▷ The multifunction relay switches in combination with the burner relay (T1–T2), run-on = 5 min

P80 = 20: Temperature-controlled circulation pump

T-CIRCL = Return flow temperature of the circulation line (measured by the multifunction sensor)

- ▷ The circulation pump is switched on when $T-CIRCL < P81$, i.e. when the return flow temperature is lower than the switching temperature of the multifunction relay (set via P81).
- ▷ The pump is switched off when $T-CIRCL > P81 + P82$, i.e. when the return flow temperature is higher than the switching temperature of the multifunction relay (set via P81) plus hysteresis (P82).
- ▷ The pump can only be switched on during the switch-on times of the hot water program (P18).

P80 = 21: Circulation pump via pulse

- ▷ The circulation pump is switched on for 5 minutes when there is a short-circuit between terminal 19 and GND.
- ▷ The pump can only be switched on during the switch-on times of the hot water program (P18).

P80 = 24: Return flow booster, heat source

T-RETURN = Return flow temperature of the system (measured by the multifunction sensor)

- ▷ The pump for the return flow boost is switched on when $T-RETURN < P81$, i.e. when the return flow temperature is lower than the switching temperature of the multifunction relay (set via P81).
- ▷ The pump is switched off when $T-RETURN > P81 + P82$, i.e. when the return flow temperature is higher than the switching temperature of the multifunction relay (set via P81) plus hysteresis (P82).

P80 = 34: Bypass valve in cooling mode

- ▷ The multifunction relay switches as soon as a central controller, e.g. Merlin, activates the operating mode “Cooling”.
- ▷ During cooling mode hot water preparation is possible by means of conventional heat sources.
- ▷ Example see page 37 (P76 Min TO Cooling (Minimum outside temperature for cooling)).

P81 Switching temperature of the multifunction relay

P81 = 30.0 – 90.0 °C: Switching requirements: see page 39 (P80 MF Relay function).

P82 Multifunction relay hysteresis

P82 = 2.0 – 10.0 °C: The multifunction relay is switched off when the measured temperature is greater than P81 + P82.

Service

P97 PC enable (0000 = disabled)

P97 = 0000–9999: Unlock code that can be used to retrieve data from the mixed heating circuit by means of the PC software “ComfortSoft”.

- Change every digit of the four-digit code no. and confirm by pressing the OK button.

P98 Relay Test

The relay test is used to check the electrical connection.

Each relay output is actuated one after the other by changing the parameter values. The corresponding output is shown in the display.

P98 = 0: No relay is controlled

P98 = 1: Heating circuit pump Direct heating circuit / multifunction relay (terminal 4)

P98 = 2: Heating circuit pump Mixed circuit (terminal 5)

P98 = 3: Storage charging pump (terminal 6)

P98 = 4: Mixer Open (terminal 7)

P98 = 5: Mixer Closed (terminal 8)

P98 = 6: Burner electrically isolated (terminals 9 – 10)

Perform relay test

- ▷ Turn the selector switch back to **Run** to cancel.
- 1** Turn selector switch to **Y** (parameter setting).
- ▷ The display shows **PL**.
- 2** Turn rotary knob until **98 0** appears in the display.
- 3** Press the OK button.
- ▷ Display jumps to **20 0000**. The first digit flashes.
- 4** Enter code no. (factory setting 0000). To do this, set each digit using the rotary and press the OK button.
- ▷ Display jumps back to **98 0** and the **0** flashes. (If an incorrect code number was entered, the display jumps back to **20 0000**. Continue with step 4.)
- 5** Use rotary knob to select the desired relay output (1, 2, 3, 4, 5 or 6) to control.
- ▷ The controlled relay output flashes in the display.
- 6** Check the device connected to the relay output for active running.
- ▷ Continue with step 5 if further relay outputs need to be checked.
- ▷ After no more than 10 minutes control of the connected device is terminated and the display of the relay to control jumps to “0”.
- 7** Press the OK button to terminate the relay test.
- ▷ Display jumps to **98 0**.
- 8** Turn selector switch back to **Run**.

P99 Software version and index (63.XX)



P99 = 63.00 - 63.99

- ▷ If you have questions about your heating controller, always specify the software version.

Expert – Checklist for commissioning

- Heating controller properly wired? Particularly the bridges between L and L1 and between GND and terminal 16, see page 21 (Connection diagram controller without socket) and page 22 (Connection diagram controller with socket).
- Are the sensors required for the application connected?
- Sensors that are not required are not connected.
- DIP switch set correctly? See page 31 (Expert – Set DIP switches).
- User parameters configured? Set at least time and day of the week, see page 8 (Set time and day of the week).
- Expert parameters configured? See page 32 (Expert – Set parameters).
- Sensors tested for plausible values? See page 8 (Display actual temperatures).
- Relay outputs tested? See page 40 (P98 Relay Test).
- Operating mode set? See page 8 (Set operating mode).
- Selector switch turned to **Run**?

Service

- 1** Remember the current operating mode.
- 2** Turn selector switch to “Mode”.
- 3** Press the OK button.
 - ▷ Display flashes.
- 4** Rotate the rotary knob clockwise up to .
- 5** Press the OK button.
- 6** Perform service.
 - ▷ The heat source heats to the max. temperature set via parameter 30. As soon as the temperature of 65 °C has been reached, the consumers regulate to their max. flow temperature for heat removal.
- 7** Press OK after you have completed the service procedure.
- 8** Use the rotary knob to set the mode back to the original operating mode.
- 9** Turn selector switch back to .
- ▷ The heating controller resets the “Service” operating mode automatically after 15 minutes.

STL Test

- ▷ You will find information on the trigger temperature of the STL in the heat source manual.
 - ▷ It is not necessary to disconnect the heating circuit pumps or the mixer for the STL test.
 - ▷ The boiler sensor must be connected.
- 1** Turn selector switch to “Mode”.
 - 2** Press and hold the OK button.
 - ▷ Display flashes and shows the actual temperature of the heat source. The temperature rises for as long as the OK button remains pressed, up to the point that STL triggers.
 - 3** Unlock the STL manually.

- ▷ If the STL does not trigger, replace STL.
- ▷ Once the OK button is released, the heating circuit pumps switch on to remove heat.

Accessories

Operating module Merlin BM, BM 8, or remote control Lago FB

The controller supports the option to connect an operating module via the CAN bus. With the operating module it becomes possible to move various operating functions and the monitoring of system values into the living space itself.

This makes operation very convenient. The technical information for the operating module describe the full range of functions in detail.

- ▷ Display of the Expert parameters
- ▷ Input of User parameters
- ▷ Room temperature control
- ▷ Automatic adaptation of the heat slope (not for Lago FB)

Merlin BM

With plain text display in the language of the country; illuminated, 4-digit display; a button is allocated to every row, very convenient to operate.

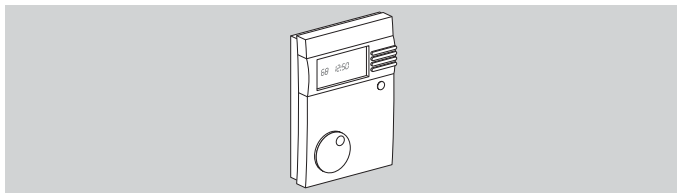

Instructions in German: Order no. 99 778 201

With instructions in language of your choice: Order no. 99 778 202

Installation and operation, see enclosed instructions.

BM 8

Plain text in language of the country and symbols in the display, operation with three buttons, easy setting of desired room temperature with rotary knob, party button and mode selection.

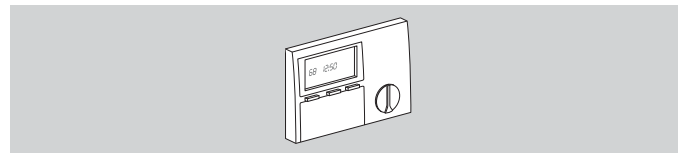

Instructions in German: Order no. 99 678 736

With instructions in language of your choice: Order no. 99 678 738

Installation and operation, see enclosed instructions.

Lago FB

Operation as for heating controller Lago 0321.

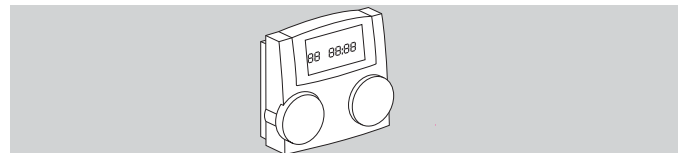

Order no. 99 678 860

Installation and operation, see enclosed instructions.

PC Adapter

For the communication between heating controller with bus and a PC. The ComfortSoft program can be used to set and retrieve all system parameters. In the PC the parameters can be saved, graphically displayed and evaluated within a specified time periods. The software is available for download at www.docuthek.com. For a connection to the PC the CoCo PC active is required, which, in combination

Accessories

with a modem, also supports sending error messages via SMS and the remote retrieval of controller data. The CoCo PC mobile is an alternative without remote retrieval or error messages via SMS.

CoCo PC active

Order no. 99 678 288

Scope of supply

CoCo PC active, instructions.

The connecting cable for the RS232 interface must be ordered separately: Order no.: 99 676 894.

CoCo PC mobile

Order no. 99 677 961

Scope of supply

CoCo PC mobile, instructions, connecting cable to USB mini-B for CAN bus or eBus.

On installation and operation, see enclosed instructions.

Remote control and room sensor FBR2

Remote control for selecting the operating mode and setting the desired room temperature

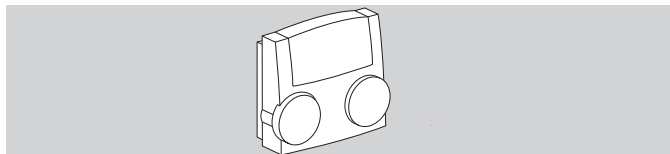

Order no. 99 679 161

Installation and operation, see enclosed instructions.

Room sensor RFB



Order no. 99 676 857

Scope of supply

Room sensor

Position of installation

- ▷ In the main living room of the heating circuit on an inside wall
- ▷ Not in the vicinity of radiators or other devices that give off heat
- ▷ Not covered by curtains
- ▷ Not influenced by draught
- ▷ The radiator valves in the room must be fully opened.

Installation

- 1** Remove upper part from base at the underside.
- 2** Screw base to the wall.
- 3** Connect electrically, see page 18 (Expert - Electrical connections).

- 4 Press upper part back on.
- 5 Set parameter 10 or 15 on the heating controller.

Sensor

Outside sensor AF/AFS

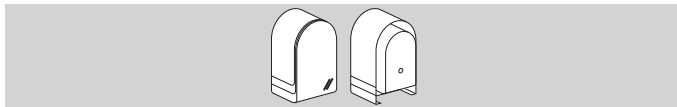

Order no. AF, 5 k Ω : 99 679 030
 Order no. AFS, 1 k Ω : 99 679 001

Scope of supply

Outside sensor, screw and dowel

Position of installation

- ▷ Ideally on a wall facing north or north-east
- ▷ Approx. 2.5 m above the ground
- ▷ Not above windows or air shafts

Installation

- 1 Pull cover off sensor.
- 2 Fasten sensor with enclosed screw.
- 3 Connect electrically, see page 18 (Expert - Electrical connections).

Boiler sensor KF/KFS

Storage sensor SPF/SPFS



Order no. KF/SPF, 5 k Ω , 3 m, \varnothing 6.0x50:
 99 676 769

Order no. KFS/SPFS, 1 k Ω , 3 m, \varnothing 6.0x50:
 99 676 682

Position of installation

In the immersion pipe of the hot water storage tank (usually on the front side of the storage tank)

Installation

- 1 Dry immersion pipe.
- 2 Insert the sensor as far as possible into the immersion pipe.
- 3 Connect electrically, see page 18 (Expert - Electrical connections).

Flow sensor VF/VFAS



Order no. VF, 5 k Ω , 3 m, \varnothing 6.0x50: 99 679 073
 Order no. VFAS, 1 k Ω , 3 m, \varnothing 6.0x50: 99 679 051

Scope of supply

Flow sensor, thermal compound, retaining strap, instructions

Position of installation

- ▷ In the case of heating system control instead of boiler sensor KF, as close as possible at the back of the boiler on the heater flow
- ▷ In the case of mixer operation approx. 0.5 m behind the heating circuit pump

Installation

- 1 Thoroughly clean flow pipe.

Accessories

2 Apply thermal compound to sensor.

3 Fasten sensor to the flow pipe with the retaining strap.

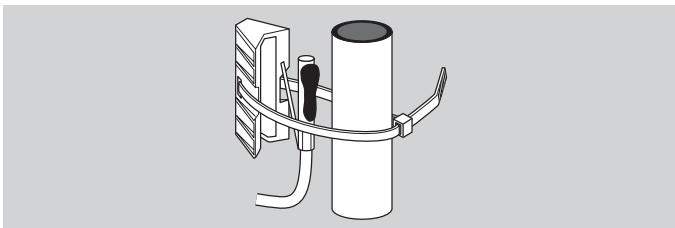

4 Connect electrically, see page 18 (Expert - Electrical connections).

- ▷ Only sensor of one type may be used.
- ▷ Set the sensor type with DIP switch 6, see page 31 (Expert – Set DIP switches).
- ▷ The sensor value of a remote control unit with room sensor FBR or a room sensor RFB is detected automatically.

Sensor values

Temp.	5 k Ω NTC: AF, KF, SPF, VF	1 k Ω PTC: AFS, KFS, SPFS, VFAS
[°C]	[Ω]	[Ω]
-60	698961	470
-50	333908	520
-40	167835	573
-30	88340	630
-20	48487	690
-10	27648	755
0	16325	823
10	9952	895
20	6247	971
25	5000	1010
30	4028	1050
40	2662	1134
50	1801	1221
60	1244	1312
70	876	1406
80	628	1505
90	458	1607
100	339	1713
110	255	1823
120	194	1936

Help with faults

? Fault

! Cause

• Remedy

When a fault occurs, the associated error number is indicated in the display.

Fault	Error no.	Defective sensor (break / short-circuit)
The mixer does not start.	E 69	Flow sensor mixer circuit VF/VFAS
The heating circuit pumps do not switch off.	E 75	Outside sensor AF/AFS
No more hot water available.	E 76	SPF/SPFS storage sensor
The flat does not get warm. No more hot water available.	E 77	Boiler sensor KF/KFS
The multifunction pump is off.	E 79	Sensor for the multifunction relay
The flat gets too warm with insolation.	E 80	Room sensor

- Check electrical connection. Replace sensor, if necessary.

? The display shows error no. E 81.

! EEPROM error. An invalid parameter has been replaced by the default value.

- Check parameter values.
- Switch mains power off and on again to reset the error no.

? The display shows error no. E 91.

- ! The set CAN bus address is already used by a different device.
- Set parameter 23 to a different address that is not yet in use.

? All radiators and the hot water storage tank are cold. But the heating controller display shows high temperatures.

? All radiators and the hot water storage tank are warm. But the heating controller display shows low temperatures.

! DIP switch 6 set to wrong sensor type.

- Set DIP switch 6 correctly:
OFF = 5 kΩ sensor (KF, SPF, VF, AF...),
ON = 1 kΩ sensor (KFS, SPFS, VFAS, AFS...)
- ▷ Never mix 1 kΩ and 5 kΩ sensors.

? When displaying the actual values on the heating controller you realise that the indicated value does not match the real one. For example, the actual hot water temperature is 20 °C, but the display shows 65 °C (or vice versa).

! 1 kΩ and 5 kΩ sensors have been mixed.

- Only use sensors with identical resistance values.

Help with faults

- ? No actual values are indicated on the heating controller.
- ! No bridge between terminal 16 and GND.
 - Check electrical connection, set bridge and load factory settings on the heating controller (Reset).

- ? Although pumps and mixer are indicated on the display they are not actuated.
- ! No bridge between terminals 2 and 3 or terminal 1 and neutral block.
 - Check electrical connection.

- ? The flat does not get warm.
- ! The heating circuits do not respond to the mode setting.
 - Set parameters 08 and 13 = “----”.
- ! The heating times at the bottom of the display do not match the desired heating program.
 - Set parameter 19: P19 = 00 for direct heating circuit, P19 = 01 for mixed heating circuit.
 - Set parameters 08 and 13 = “----”.
- ! Pump for direct heating circuit is not running.
 - Set DIP switch 4 to “Pump direct heating circuit”.

- ? The hot water stays cold during summer mode.
- ! Parameter 18 = 03 set (hot water 1 h before heating)
 - Set P18 = 01 or 02.

Should the actions described above fail to help, please contact your heating engineer.

▷ Please have ready the software version (parameter P99).

Technical data

Mains voltage according to DIN IEC 60 038:

230 V~, ±10%

Power consumption: max. 5 VA

Switching capacity of the relays: 250 V~, 2 (2) A

Max. current via terminal L1': 6.3 A

Protection class according to DIN EN 60529: IP 40

Protection class according to DIN EN 60730: I

Reserve power of clock: >10 h.

Permissible ambient temperature during operation: 0 to 50 °C

Permissible ambient temperature during storage: -20 to 60 °C

Permissible relative humidity, not condensing: 95 % r. H.

Sensor resistances: NTC 5 kΩ (AF, KF/SPF, VF),

Tolerance in ohms: ±1 % at 25 °C,

Temperature tolerance: ±1.3 °C at 25 °C

Sensor resistances:

PTC 1010 Ω, (AFS, KFS, SPFS, VFAS)

Tolerance in ohms: ±1 % at 25 °C,

Temperature tolerance: ±0.3 °C at 25 °C

Glossary

Flow and return flow temperature

The flow temperature is the temperature to which the heat source heats the water that transfers the heat to the consumer (e.g. radiator). The return flow temperature is the temperature of the water that flows back from the consumer to the heat source.

Desired and actual temperature

The desired temperature (or setpoint temperature) describes the desired temperature for a room or for hot water. The actual temperature denotes the actual temperature that prevails. The heating controller has the task to adjust the actual temperature to the desired temperature.

Setback temperature

The setback temperature is the desired temperature to which the heating system heats outside heating times (e.g. at night). It should be set so that the rooms do not cool down too much while saving energy.

Heat source

Heat source is generally the designation for the heating boiler. It may also be a buffer storage tank however.

Circulation pump

The circulation pump ensures that there is constant hot water available. The hot water is held in the storage tank. The circulation pump circulates it via the fresh water pipes in accordance with the heating program.

Return flow booster

The return flow booster prevents the temperature difference at the heat source between flow and return becoming too great. A mixing valve is here used to add a portion of the hot flow water to the return flow to prevent condensation of the steam from the heating gas against the cold heat carrier inside the heating boiler. The minimum temperature required for this process inside the heating boiler depends on the type of fuel (oil 47 °C, gas 55 °C). The risk of corrosion inside the heating boiler is thereby reduced significantly.

Direct heating circuit

In the direct heating circuit the flow temperature is identical to the heat source temperature, i.e. the direct heating circuit is operated with the maximum temperature.

Mixed heating circuit / Mixer circuit

In the mixed heating circuit a three-way valve is used to add cooled water from the return flow to the hot flow water. The flow temperature is thus reduced. This is important for underfloor heating systems, for example, because they must only be operated with low flow temperatures.

Heating time

In the heating programs you can define up to three heating times per day, one for the morning, one for lunchtime, and one for the evening for example. During a heating time, the temperature is controlled to the desired room temperature. Between heating times the temperature is controlled to the setback temperature.

Header pump

A header pump is used to pump the hot water in a system with one or several heat sources. It is switched on as soon as a consumer in the system requests heat.

Feed pump

A feed pump functions like a header pump. It is switched on as soon as an internal consumer in the system requests heat.

Legionella

Legionella are bacteria that live in water. The hot water storage tank is heated to 65 °C every 20th heating period or at least once a week as protection against these bacteria.

Declaration of conformity



We the manufacturer declare the product Lago 0321 is in conformity with the fundamental requirements of the following directives and standards.

Directives:

- 73/23/EEC,
- 89/336/EEC

Standards:

- EN 60730-1
- EN 60730-2-9
- EN 55014-1
- EN 55014-2

The manufacture is subject to the quality management system in accordance with DIN EN ISO 9001.

Elster GmbH

Scan of the declaration of conformity (D, GB) – see www.docuthek.com

Contact

Heating circuit allocation

For the installation expert

Please enter which rooms the heating circuits are assigned to here.

Direct heating circuit	Mixed heating circuit

Contact

If you have any technical questions, please contact your local branch office/agent. The addresses are available on the Internet or from Elster GmbH.

We reserve the right to make technical modifications in the interests of progress.

elster
Kromschöder

Elster GmbH
Geschäftssegment Comfort Controls
Kuhbrückenstraße 2–4 · 31785 Hameln
www.kromschroeder.de



CDOC001471

04/16